



TR16H Battery Capacity Tester

# Instruction

## Diagram of Product



## Function and Application Range

● TR16 is a common high-accuracy current collecting type of coulombmeter, it can correctly measure voltage, current, capacity in real time. It can help user accurately understand work status of battery pack, with power-down memory function.

● Applicable for portable device, balance bike, electric car, vacuum cleaner, measuring device, medical device, various instruments, etc.

## Applicable Battery Specification

● This product is applicable for 8V~120V battery pack, such as lithium battery, lithium iron phosphate battery, lead-acid battery, nickel metal hydride batteries, etc.

## Technical Parameter

Parameter	Min.	Regular	Max.	Unit
Working voltage	8.0		120.0	v
Working Consumption		10.0	12.0	mA
Stand-by Consumption		0.5	0.6	mA
Sleep Consumption		50.0	60	uA
Accuracy of Voltage Collecting		±1.0		%
Accuracy of Current Collecting		±1.0		%
Accuracy of Capacity Collecting		±1.0		%
Backlight on current(50A specification)		50		mA
Backlight on current(>50A specification)		100		mA
Setting Value of Capacity	0.1		999.0	AH
50A Sampler Current	0	50.0	75.0	A
100A Sampler Current	0	100.0	150.0	A
350A Sampler Current	0	350.0	500.0	A
Temperature Range in Application Environment	-10	20	60	°C
Weight (50A/100A/350A)		200/270/410		g
Appearance size		ø59*20		mm
Hole size		ø54.50		mm

Notes: This product shall be used with sampler (the internal parameters are different), the different samplers cannot be used with meters. The heating components of sampler shall be installed at the ventilated position and be prohibited to cover! For long term use with max. current, please keep ventilating and cooling.

## Instruction of Working Interface

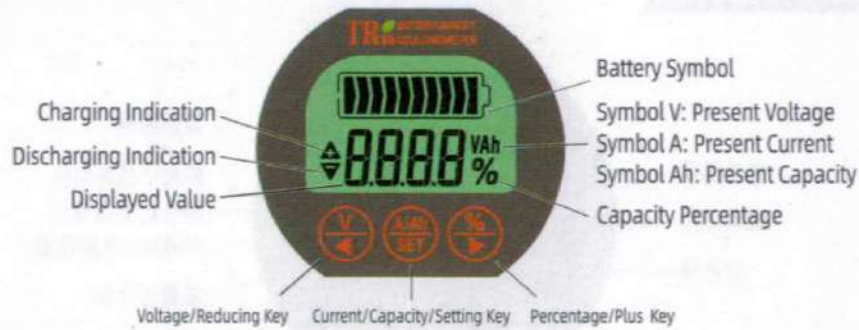

## Connection Method

1. **First**, connect the sampler in series with the negative circuit of the battery pack. B- on sampler connects to B- of battery pack, and P- connects to P-/C- of charging and discharging.
2. **Then** take a piece of 0.3-0.75 mm<sup>2</sup> red wire, one end connects to B+ of the battery pack, and the other end connects to any B+ binding post on the sampler.
3. **Finally**, connect one end of the shielded wire to the sampler socket, and the other end connects to the TR16 socket. After confirmation, it can work when being electrified. (Connection diagram is schematic diagram, not isometric diagram).
4. Connection Principle: **Ensure that all current shall pass through sampler!**

### ★ Connection diagram of 50A sampler:

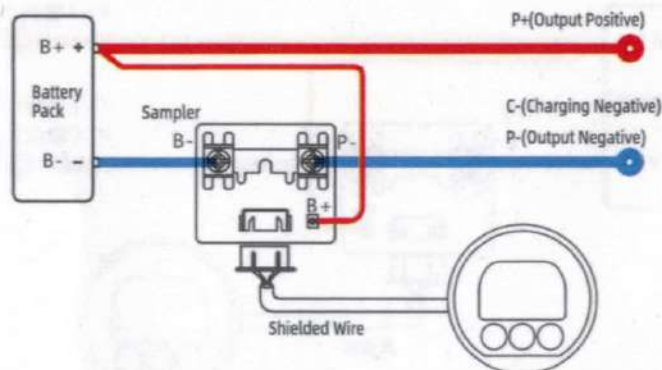

### ★ Connection diagram of 100A/350A sampler:

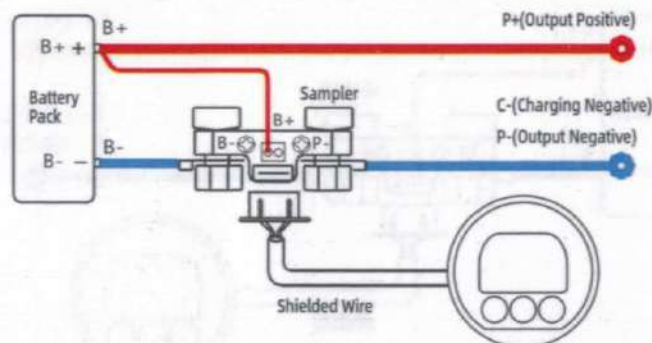

Notes: TR16 is equipped with a sampler, the shielded wires are different due to required length, which is required to purchase individually (length 0.5m to 10m for option) Please connect wire strictly based on connection diagram, the sampler must connect to the negative circuit of battery, the sampler cannot connect to positive circuit! It is forbidden to lengthen or cut the shield wire!

## Installation Method

● Open a 54.5mm round hole on the installed equipment panel, put the monitor into the hole from the front of panel, and then tighten the installation supporter from the back with butterfly nut. As shown in the following figure:



Notes: The "equipment panel" doesn't belong to product.



## Steps of Uses

1. Check the current: Power on after finishing connection, the screen displays numerical value (if no display, check the connection when power off). Discharge or charge the coulometer, press the  key switch to the current display, and **check whether the displayed current value is consistent with the actual current value.** If the error is big, please check the connection

2. The battery capacity should be set for the first use. See "parameter setting → capacity setting" for the method.

(if the battery capacity is unknown, please refer to "parameter setting → detection and reset of actual effective capacity") for the method.

3. The meter displays capacity zero and full-power operation (capacity reset): the percentage and capacity displayed on the screen when using for the first time are not the current actual values of the battery, it needs to use zero capacity or full-capacity operation to reset the meter capacity.

Method 1: After fully discharge battery, press  key switch to percentage display, **holding  key for 3 seconds to set zero capacity to display 0%.**

Method 2: After fully charge battery, **holding  key for 3 seconds to set full capacity to display 100%.**

## Function Instruction

1. When charge/discharge, the coulombmeter must work, otherwise battery capacity cannot calculate.

2. Connect load, when discharge current is bigger than backlight on current, Backlight on (If backlight flickers, it means the B- and P- of sampler are reserved), the screen displays discharging symbol , it means discharging.

3. Disconnect load, connect charger, when charge current is bigger than backlight on current, the backlight flickers (If backlight is always on, it means the B- and P- of sampler are reserved), the screen displays charging symbol , it means charging.

4. When charge or discharge current value is smaller than backlight turn-off current, coulombmeter enters into low consumption status, the backlight is off; and coulombmeter will memorize capacity but not lose (namely power-down auto memory function).



5. The coulombmeter sensitivity is high, under stand-by (the battery pack doesn't have input or output current), it is interrupted by nearby electric equipments( such as turning on or off the motor and other inductive loads), it may cause the backlight turn on for short time, it is normal.

6. The coulombmeter may have errors when current severely changing, it affects on sampling accuracy.

## Parameter Setting

### ● Display Interface Switch:

Press  key to display present voltage;



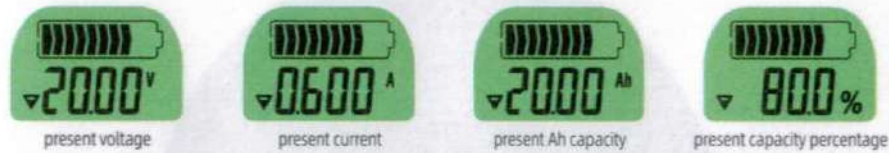

Press  key to display present current, then press  key to display present Ah capacity;

Press  key to display present capacity percentage. As shown in the figure:







● Check and reset the actual battery effective capacity (the capacity value has error): set the meter to zero capacity after fully discharging, and enter the capacity setting interface to set the Ah value as large (for example, set the estimated 20Ah as 30Ah). Then re-charge the battery pack, and the display value of coulombmeter after fully charging is the effective actual capacity of the battery pack, and re-enter the capacity setting interface to modify the value into the effective capacity. If the battery capacity decays, this operation should also be carried out, otherwise the percentage shows error.

### ● Capacity Setting:

In Ah capacity interface, holding  key for 3 seconds, enter into capacity setting interface. The setting value flickers, press  key to reduce value, press  key to increase value, Press and hold to continuously adjust, after finishing setting, press  key to finish setting and exit.

● Zero capacity voltage setting (When voltage lower than setting value, capacity automatically zero)

In voltage interface, holding  key for 3 seconds, enter into zero capacity voltage setting interface. Setting value flickers, press  key to reduce value, press  key to increase value, after finishing setting, press  key to finish setting and exit. When battery voltage lower than setting value, capacity is automatically set as 0%.

Notes: zero capacity voltage is defaulted as 0V, which means ineffective and no setup required. If it needs to be set, the actual charge/discharge voltage of battery pack needs to be understood.

## Attention and Warranty

● The monitor cannot be under sunlight for a long time, cannot be under below  $-10^{\circ}\text{C}$  and above  $60^{\circ}\text{C}$  for long periods of time, otherwise the lifetime of LCD screen of monitor will be short.

● This product is guaranteed within one year from the date of purchase. If there are non-artificial quality problems in this period, it can be repaired for free.

This product may be technically improved or updated. If your purchased product is different from the product appearance and technical parameters described in the Product Instruction Manual, please refer to the material object or website introduction.